

Hardware Reference Manual

64K RAM Board

Central Data Corporation

64K RAM Board Manual

Central Data Corporation
P.O. Box 2484, Station A
Champaign, IL 61820
Phone: (217) 359-8010

Copyright (C) 1978, Central Data Corporation

TABLE OF CONTENTS

<u>Section</u>	<u>Page</u>
1.0 Warrantee.....	1
2.0 Description.....	1
3.0 Processor Selection.....	1
4.0 Address Selection.....	2
4.1 8080 or Z80 Processors.....	2
4.1.1 16K/32K Boards.....	2
4.1.2 48K/64K Boards.....	3
4.2 2650 Processors.....	4
5.0 Address Deselect Straps.....	5
6.0 Installation.....	6
7.0 Increasing your Memory Size.....	6
8.0 Specifications.....	7
9.0 8080 Memory Test Program.....	8
10.0 2650 Memory Test Program.....	10
11.0 Schematics.....	13

1.0 Warrantee

The Central Data 64K RAM Board is fully warranteed for a period of one year following the date of shipment. All units returned to Central Data Corporation postpaid during this period will be repaired and returned without charge.

This warrantee does not apply to boards which have been damaged, abused, or modified. Central Data reserves the right to change the design of the RAM Board without having to change any previously manufactured units.

2.0 Description

The Central Data 64K RAM Board is a random access read/write memory module designed to expand the memory capacity of S-100 computers. The Board is configured as four sections of 16K x 8 bits. The sections are seperately addressable.

The memory integrated circuits used on the 64K RAM board are 4116-25 16K (or equivalent) dynamic RAMs for 2MHz boards, 4116-20 RAMs for 4MHz boards. These RAM's use considerably less power than static RAM as well as using less PC board space.

The circuitry has been designed to be independent of the processor type. This manual shows how to set up the board to be accessed by S-100 systems using the 8080, Z80, or 2650 microprocessors. It will work with other types of bus masters as long as they simulate the memory access timing of the processor for which the board is strapped.

3.0 Processor Selection

First, there are two straps numbered 14 and 15 soldered on the board which determine which S-100 line is used for reset in your system. Strap 14 selects pin 75 as the reset source, and strap 15 selects pin 99 as the reset source. Normally, the board will work as strapped at the factory (for pin 75), but if you find that your board will not hold data during reset operations, you can change the strap to fix the problem. The strap locations can be found on the parts placement diagram at the end of this manual.

Two 16 pin DIP headers are used to program the RAM Board for use with various processors. Wires must be soldered in place connecting across these headers. The correct connections are shown in figure 1.

8080 PROCESSOR:

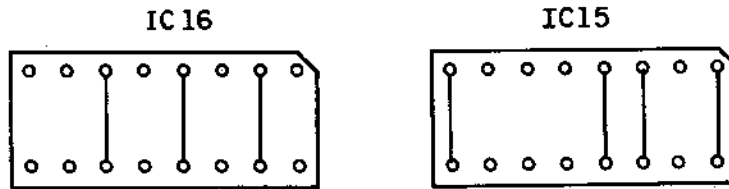

Z-80 PROCESSOR:

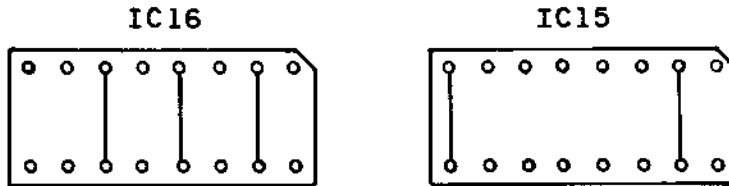

2650 PROCESSOR:

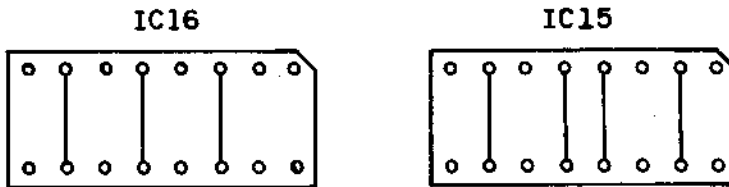

Figure 1

Two alternates for the Z-80 processor would be: on IC15, take out the wire between pins 8 and 9 and add a wire between pins 7 and 10. Then also add a wire between either pins 6 and 11 or pins 5 and 12, depending on which alternate you try. This changes the clock used in the refresh circuit.

4.0 Address Selection

When the RAM Board is used in an 8080 or Z80 system it will be addressable on 16K boundaries. When strapped for use in a 2650 system, it will be addressable on 8K boundaries. Two sets of address selection instructions are given below. Follow the instructions that correspond to the processor type being used.

4.1 Address Selection Instructions for 8080 or Z80 Systems

When strapped for 8080 or Z80 bus masters, the 64K RAM Board consists of up to four separate 16K sections. Each section can be addressed independently and can occupy any 16K block of memory address space.

For each 16K section there will be one blue "minijump" connector bridging the address selection area (16K boards will use one address strap minijump, 32K boards will use two, etc.). Refer to Figure 2 for the location of this area on the board. The exact placement of the minijumps will vary depending on whether you have a board with 16K or 32K of memory or one with 48K or 64K of memory. The detail on how to address the board is presented below in two sections, depending on the size of board that you have.

4.1.1 Addressing 16K/32K Boards with 8080 or Z80 Systems

For a 16K or 32K board, you will need to place one or two minijumps (depending on the board size) in the address selection strap area. The minijump for the top row of chips should be placed in the top row of the address selection strap area (see Figure 2). The minijump should be placed over the set of pins marked 0, 1, 2, or 3 to address the top row of RAMs to start at 0, H4000, H8000, or HC000. For a 32K board the second row of RAMs can be addressed in the same way, but with the minijump placed in the bottom row of the address selection strap area. Figure 2 shows the addressing for a 32K board whose top row of RAM's is addressed to start at H8000, and its second row of RAMs is addressed to start at HC000. The deselection straps shown in the figure have no effect on the basic addressing of the board and are explained in section 5.

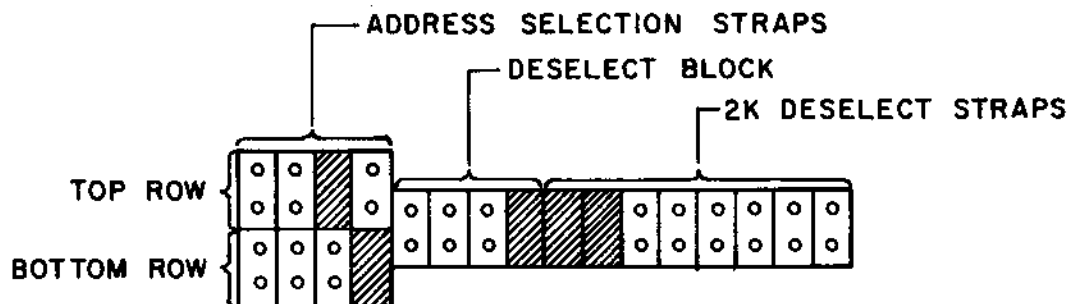

Figure 2

4.1.2 Addressing for 48K/64K Boards on 8080 or Z80 Systems

For a 48K or 64K board, you will have to place three or four minijumps (depending on the board size) in the address selection strap area. One minijump will be used for each 16K block that you address. To address the first 32K of the board (the top two rows of RAMs), you will place two minijumps on the top row of the address selection strap area (see Figure 3). Each minijump should be placed to select

where a corresponding 16K block of memory should be addressed. A minijump is placed in column 0, 1, 2, or 3 to start addressing for the 16K section at address 0, H4000, H8000, or HC000. There is one restriction: the two minijumps must be adjacent. This means that the allowable combinations for addressing the first 32K of your board are:

0,1	(address 0 to H7FFF)
1,2	(address H4000 to HBFFF)
2,3	(address H8000 to HFFFF)
3,0	(address HC000 to H3FFF)

At this point, the remaining memory on the board can be addressed. To address the last 16K of a 48K board, a single minijump is placed in the correct column of the bottom row of the address selection strap area. For a 64K board, two minijumps are placed on the bottom row, addressing the bottom 32K of memory on the board. Note that these two minijumps must be adjacent as in selecting the top 32K of memory. Figure 3 shows a 48K board addressed from 0 to HBFFF.

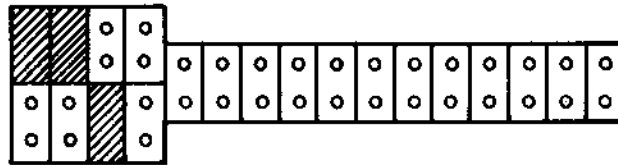

Figure 3

With regard to 48K boards only, the last 16K of memory corresponds to the eight memory chips located either in the third or fourth row of the socketed memory area. If you are addressing this 16K segment to begin on an even 32K boundary (to start at address 0 or H8000) then the row of memory chips must be in the fourth (bottom) row of the memory area on the board. If you are addressing this 16K segment to begin at either H4000 or HC000 then the memory devices must be placed in the third row of sockets in the memory area (adjacent to the top 32K of memory). When the boards are shipped from Central Data they contain the memory on the bottom row of the board.

4.2 Addressing Instructions for 2650 Processors

To address a 16K board to be used in a 2650 system, put a minijump in positions 1 and 2 of the top row of the address selection strap area (see Figure 4). This addresses the board to have a continuous 16K of memory starting at address H2000.

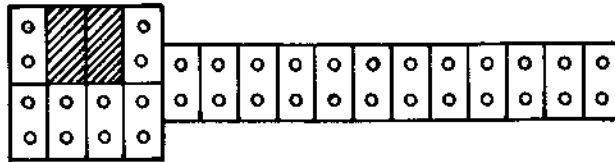

Figure 4

To address a 32K board for a 2650 system, you will have to deselect the portions of page zero which are used by the CPU board. The straps should be set up as shown in Figure 5 for this configuration.

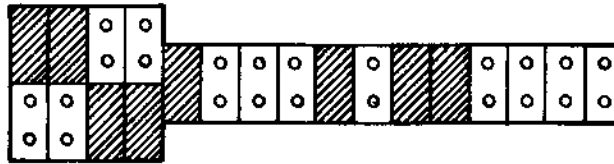

Figure 5

5.0 Address Deselect Straps

In order to have the RAM Board fit around ROM monitors or other dedicated areas of memory, from one to eight 2K segments of any 16K address space can be deselected. The instructions for setting these straps are given for all non-2650 systems. Any 2650 users which need this feature should consult the factory.

Use a minijump to select the 16K area in which the gap will occur. Place the minijump in the column of the "Deselect Block" area that corresponds to this block of memory. Now place a minijump in each column of the "Deselect Strap" area that you wish to have deselected.

Example:

You have a SOL-20 computer and wish to use the ALS-8 program which requires 12K of memory from HD000 to HFFFF. A full 16K of RAM (HC000 to HFFFF) won't work because the monitor (SOLOS) occupies 2K of memory space between HC000 and HC7FF. Also, the SOL-20 has 2K of RAM between HC800 and HCFFF.

A Central Data RAM Board can be used for this purpose by deselecting the occupied areas. Put a minijump in the address selection area to address the 16K of the board from HC000 to HFFFF (see section 4.1). Since the area to be deselected is in the top 16K put a minijump in column 3 of

the "Deselect Block." Now put a minjump in both column 0 and column 1 of the "Deselect Strap" section of the board to deselect the lowest 4K of this 16K. The board is now strapped to occupy the 12K from HD000 to HFFFF. Figure 2 shows a RAM Board addressed this way.

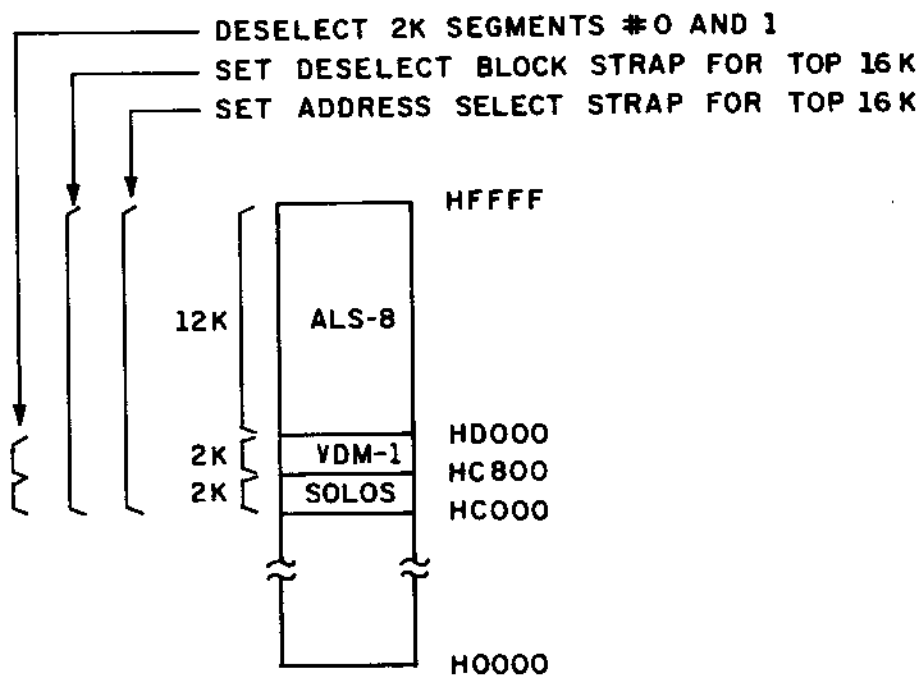

Figure 6

6.0 Installation

Before plugging the RAM Board into an S-100 card slot, make certain that the power has been off long enough to allow the power supply capacitors to discharge. Whenever any S-100 board is plugged in or removed, care should be taken to make sure that the edge connector lines up with the printed circuit board fingers.

Keeping these precautions in mind, put the board into the S-100 mainframe. Make sure the board faces the right direction. The power may now be applied. The RAM Board is ready for use.

7.0 Increasing your Memory Size

To increase the memory capacity of your board, you can purchase a set of memory ICs and capacitors from Central Data. The memory circuits should be carefully plugged into the next available row of sockets from the top of the board. The only exception to this is when you are upgrading to a 48K board where you may need to skip the third row in order to address the board correctly (see section 4.1.2 for

information concerning this).

The capacitors should be soldered in according to the parts placement diagram making sure of the polarity on the tantalum capacitors. The capacitors in the memory area of the parts placement diagram are numbered to indicate which ones are to be put in for the different sizes of boards. Capacitors with the number '1' should all be in for 16K boards, while 32K board should have capacitors for both numbers '1' and '2', etc.

Finally, if you upgraded a 16K or 32K board to a 48K or 64K board, you will have to change two jumper straps on the board. These are the straps numbered 1, 2, 3, and 4 on the parts placement diagram, and they should be wired as follows for the different sizes of boards:



8.0 Specifications

Storage Capacity	16K, 32K, 48K, or 64K
Addressing	16K boundaries
Buffering	On all I/O lines
Access Time - 2MHz Bd.	450ns(max)
4MHz Bd.	250ns(max)
Cycle Time	480ns(max)
Refresh Period	15us(max)
Wait States Generated	None
DMA Rate	1MHz Max

Power Consumption (16K, typ.):	
+16	150ma
+8	300ma
-16	20ma

Power Consumption (each add'l 16K, typ.):	
+16V.	20ma
+8V.	0ma
-16V.	3ma

9.0 8080 Memory Test Program

The memory test program listed below can be used to test a 16K memory segment addressed for Block 1 (H4000-H7FFF). When an error is found the program stores information about the error and then halts. The error information is stored as follows:

<u>Address</u>	<u>Information</u>
H0003	High byte of address
H0002	Low byte of address
H0001	Data written to byte
H0000	Data read from byte

A 32K memory segment can be tested by addressing the board for blocks 1 and 2 and changing the values at locations H16 and H2C to HC0.

This memory test program occupies memory starting at H0000 so a working RAM board must be at this part of memory.

ADDRESS	BEG	EQU	4000	HEX STARTING
END ADDR	END	EQU	80	TOP BYTE OF
	*			
0004 31 04 00	START	ORG	4	
0007 AF		LXI	SP,4	
0008 47		XRA	A	
0009 21 00 40	OVER	MOV	B,A	CLEAR A,B
000C 48		LXI	H,BEG	STARTING ADDR
000D 71	WRITE	MOV	C,B	
000E 23		MOV	M,C	STORE DATA
000F 0C		INX	H	BUMP ADDRESS
0010 C2 14 00		INR	C	BUMP DATA
0013 0C		JNZ	SKIP	
		INR	C	OFFSET PATTERN
0014 7C	SKIP	MOV	A,H	
0015 FE 80		CPI	END	
0017 C2 0D 00		JNZ	WRITE	
	*			
	*			
	*			
				READ BACK LOOP
001A 78		MOV	A,B	
0018 21 00 40		LXI	H,BEG	
001E 5E	READ	MOV	E,M	
001F BB		CMP	E	
0020 C2 35 00		JNZ	ERROR	
0023 23		INX	H	
0024 3C		INR	A	
0025 C2 29 00		JNZ	NDINC	
0028 3C		INR	A	
0029 4F	NDINC	MOV	C,A	
002A 7C		MOV	A,H	
002B FE 80		CPI	END	
002D 79		MOV	A,C	
002E C2 1E 00		JNZ	READ	
0031 04		INR	B	
0032 C3 09 00		JMP	OVER	
	*			
	*			
	*			
				ERROR ROUTINE
0035 E5	ERROR	PUSH	H	
0036 57		MOV	D,A	
0037 D5		PUSH	D	
0038 76		HLT		

10.0 2650 Memory Test Program

A memory test program for the 2650 is listed here. The program loads into display memory at H1510 and occupies about 800 bytes. To set the address range to test, simply set the two bytes labeled STARTT and ENDT to the high bytes of the starting and ending addresses. For example, if you wanted to test memory between H2000 and H5FFF, you would change STARTT to H20 and ENDT to H60. Then just execute at 1510, and the test will begin. Since the program occupies display RAM, the screen will be broken up when it is being executed. The program terminates when a key is pressed. Errors are displayed on the screen in the following format:

```

+-----Address of the error
!   +-----Data that was written there
!   !   +-----Data that was read back
!   !   !
XXXX XX XX
```

```

0001 0000                                PRNT
0002 0000                                *
0003 0000                                *
0004 0000                                *
000F 0000                                *      MEMORY TEST
0006 0000                                *
0007 0000                                *
0008 0000                                *
0009 0000      EQ      EQU      0      POSSIBLE CONDITIONS
0010 0000      GT      EQU      1
0011 0000      LT      EQU      2
0012 0000      UN      EQU      3
0013 0000      R0      EQU      0      REGISTER DEFINITIONS
0014 0000      R1      EQU      1
0015 0000      R2      EQU      2
0016 0000      R3      EQU      3
0017 0000      HXOT    EQU      006A
0018 0000      LFCR    EQU      0024
0019 0000      WCHR    EQU      0396
0020 0000      RETU    EQU      0083
0021 0000      *
0022 0000      *
0023 0000      *
0024 1510                                ORG      1510
0025 1510 1B 02                                BCTR,UN  START  BRANCH OVER PCINTERS
0026 1512 00                                STARTT  RES      1      HIGH BYTE OF START ADDRESS
0027 1513 00                                ENDT    RES      1      HIGH BYTE OF END ADDRESS+1
0028 1514 04 00                                START  LODI,R0  0
0029 1516 93                                LPSL
0030 1517 3F 00 24                                BSTA UN  LFCR    SETUP PSL
0031 151A 20                                STRT    EORZ,R0  DO LINEFEED AT BEGINNING
0032 151P 09 75                                LODR,R1  STARTT  GET READY TO CLEAR LOW BYTE OF
0033 151D C9 29                                STRR,R1  RAMPTR  GET HIGH BYTE OF START ADDRESS
0034 151F C8 28                                STRR,R0  RAMPTR+1 STORE INTO POINTER
0035 1521 05 FF                                LODI,R1  FF      ZERO LOW BYTE OF POINTER
0036 1523 8F 01                                WRT     ADDI,R1  1      SETUP STARTING DATA
0037 1525 01                                LODZ,R1  1      ADD 1 TO STARTING DATA
0038 1526 06 00                                WSTL    LODI,R2  PUT IT IN R0 FOR USE
0039 1528 CF F5 48                                WRTLFP  STRA,R2  0      SETUP INDEX REGISTER
0040 152B 84 01                                ADDI,R0  *RAMPTR,I  STORE NEXT BYTE
0041 152D 98 02                                BCFR,EQ  1      INCREMENT DATA
0042 152F 84 01                                ADDI,R0  WTSKP   IF ZERO DONT BRANCH
0043 1531 DA 75                                BIRF,R2  1      DONT LET ZERO BE STORED
0044 1533 72                                REDD,R2  WRTLFP  DC 256 TIMES
0045 1534 9E 00 83                                BCFA,LT  RETU    READ THE KEYBOARD
0046 1537 0A 0F                                LODR,R2  RAMPTR  RETURN IF KEY IS PRESSED
0047 1539 86 01                                ADDI,R2  1      INCREMENT POINTER
0048 153B CA 0B                                STRR,R2  RAMPTR
0049 153D EE 15 13                                COMA,R2  ENDT    SEE IF END OF TEST AREA
0050 1540 98 64                                BCFR,EQ  WSTL    IF NCT, BRANCH
0051 1542 0A 4E                                LODR,R2  STARTT  SETUP FOR START OF TEST AREA
0052 1544 CA 02                                STRR,R2  RAMPTR
0053 1546 1B 02                                BCTR,UN  RD      START READ LOOP

```

0054	1548		*						
0055	1548		*						
0056	1548		*						
0057	1548	00 00	RAMPTR	RES		2			
0058	154A		*						
0059	154A		*						
0060	154A		*						
0061	154A	01	RD	LODZ,R1				LOAD THE STARTING DATA VALUE	
0062	154B	C3		STRZ,R3				SAVE IT IN R3	
0063	154C	06 00	RSTL	LODI,R2		0		SETUP INDEX REGISTER	
0064	154E	0E F5 48	RDLP	LODA,R2		*RAMPTR,I		GET NEXT DATA BYTE	
0065	1551	E3		COMZ,R3				COMPARE TO WHAT IT SHOULD BE	
0066	1552	B8 23		BSFR,E0		ERROR		IF NCT THE SAME, GOTC ERROR	
0067	1554	87 01		ADDI,R3		1		INCREMENT DATA	
0068	1556	98 02		BCFR,EQ		RDSKP		DONT ALLOW ZERO AGAIN	
0069	155E	87 01		ADDI,R3		1			
0070	155A	DA 72	RDSKP	BIRR,R2		RDLP		DO THIS LOOP 256 TIMES	
0071	155C	72		REDD,R2				READ KEYBOARD	
0072	155D	9E 00 83		BCFA,LT		RETU		RETURN IF KEY IS PRESSED	
0073	1560	0A 66		LODR,R2		RAMPTR		INCREMENT RAM POINTER	
0074	1562	86 01		ADDI,R2		1			
0075	1564	CA 62		STRR,R2		RAMPTR			
0076	1566	EE 15 13		COMA,R2		ENDT		SEE IF END OF TEST AREA	
0077	1569	98 61		BCFR,EQ		RSTL		IF NCT, BRANCH	
0078	156B	0E 15 12		LODA,R2		STARTT		REDO THE WHOLE THING AGAIN	
0079	156E	CA 58		STRR,R2		RAMPTR			
0080	1570	1F 15 23		BCTA,UN		WRT			
0081	1573		*						
0082	1573		*						
0083	1573		*						
0084	1573	00 00 00	TMP0	RES		4			
0085	1577		*						
0086	1577		*						
0087	1577		*						
0088	1577	C8 7A	ERROR	STRR,R0		TMP0		SAVE THE REGISTERS	
0089	1579	C9 79		STRR,R1		TMP0+1			
0090	157B	CA 78		STRR,R2		TMP0+2			
0091	157D	CB 77		STRR,R3		TMP0+3			
0092	157F	0A 47		LODR,R2		RAMPTR		LOAD THE HIGH BYTE	
0093	1581	3F 00 6A		BSTA,UN		HXOT		WRITE IT	
0094	1584	0A 6F		LODR,R2		TMP0+2		WRITE THE LOW BYTE	
0095	1586	3F 00 6A		BSTA,UN		HXOT			
0096	1589	07 20		LODI,R3		20		WRITE A SPACE	
0097	158B	3F 03 96		BSTA,UN		WCHR			
0098	158E	0A 66		LODR,R2		TMP0+3		WRITE THE DATA WRITTEN	
0099	1590	3F 00 6A		BSTA,UN		HXOT			
0100	1593	07 20		LODI,R3		20		WRITE A SPACE	
0101	1595	3F 03 96		BSTA,UN		WCHR			
0102	1598	0A 59		LODR,R2		TMP0		WRITE THE DATA READ	
0103	159A	3F 00 6A		BSTA,UN		HXOT			
0104	159D	3F 00 24		BSTA,UN		LFCR			
0105	15A0	08 51		LODR,R0		TMP0		RESTORE THE REGISTERS	
0106	15A2	09 50		LODR,R1		TMP0+1			
0107	15A4	0A 4F		LODR,R2		TMP0+2			
0108	15A6	0B 4E		LODR,R3		TMP0+3			
0109	15A8	17		RETC,UN				RETURN	

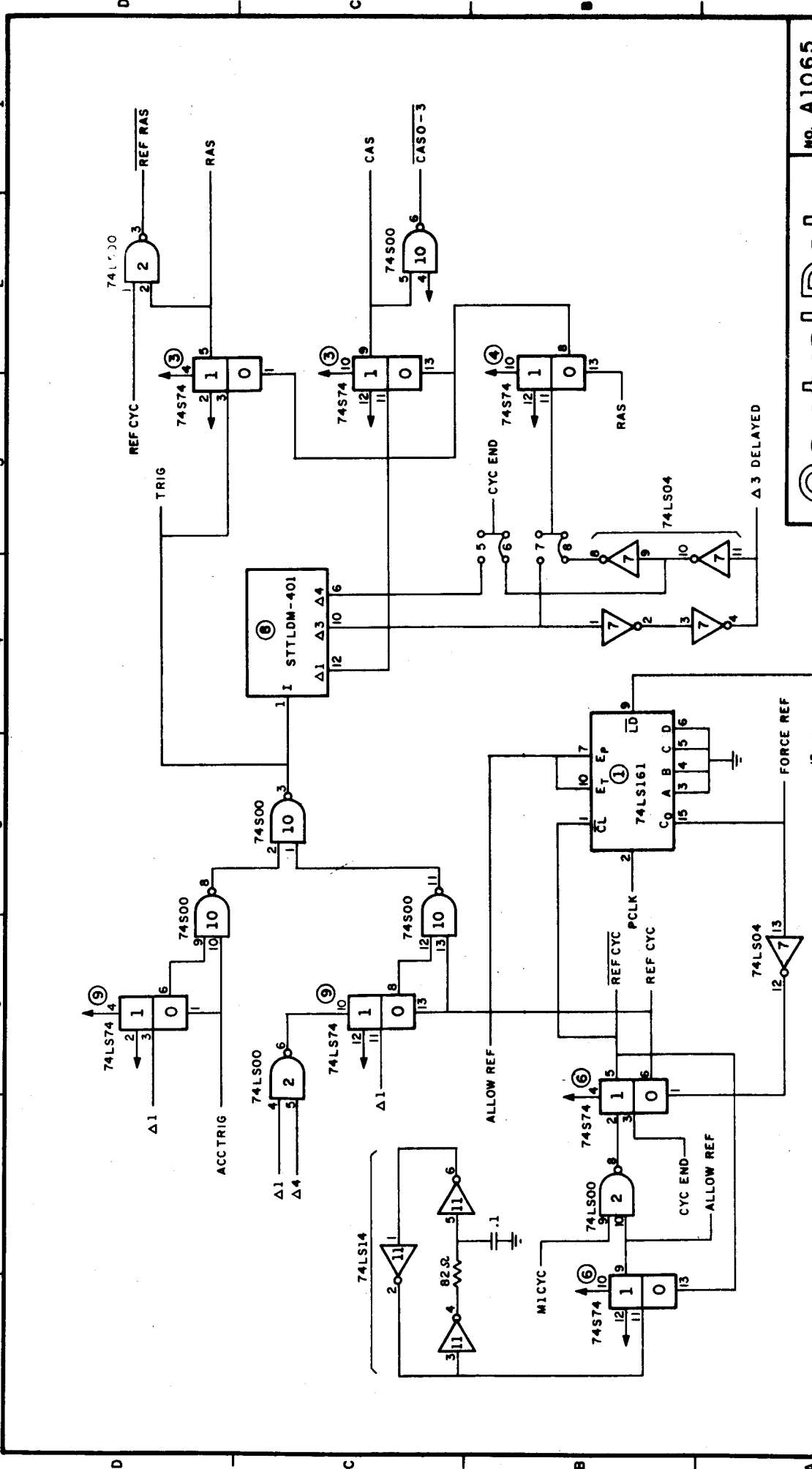

NO. A1065
SHEET 1 OF 5

Central Data

64 K RAM BOARD

TIMING / REFRESH

1 2 3 4 5 6 7 8

1 2 3 4 5 6 7 8

8 7 6 5 4 3 2 1

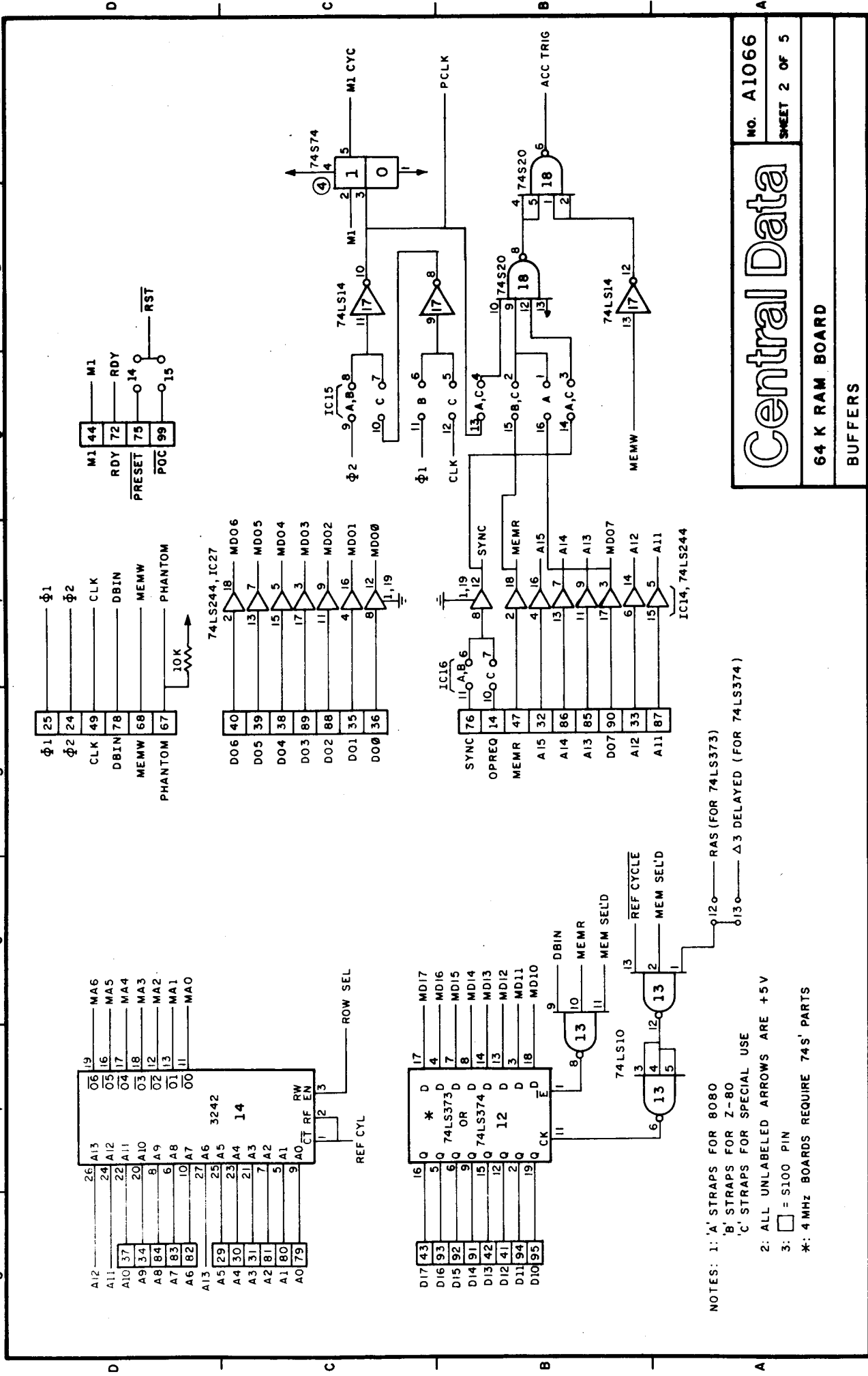

NOTES: 1: 'A' STRAPS FOR 8080
 'B' STRAPS FOR Z-80
 'C' STRAPS FOR SPECIAL USE
 2: ALL UNLABELED ARROWS ARE +5V
 3: □ = S100 PIN
 *: 4 MHz BOARDS REQUIRE 74S' PARTS

Central Data

NO. A1066

SHEET 2 OF 5

64 K RAM BOARD

BUFFERS

1 2 3 4 5 6 7 8

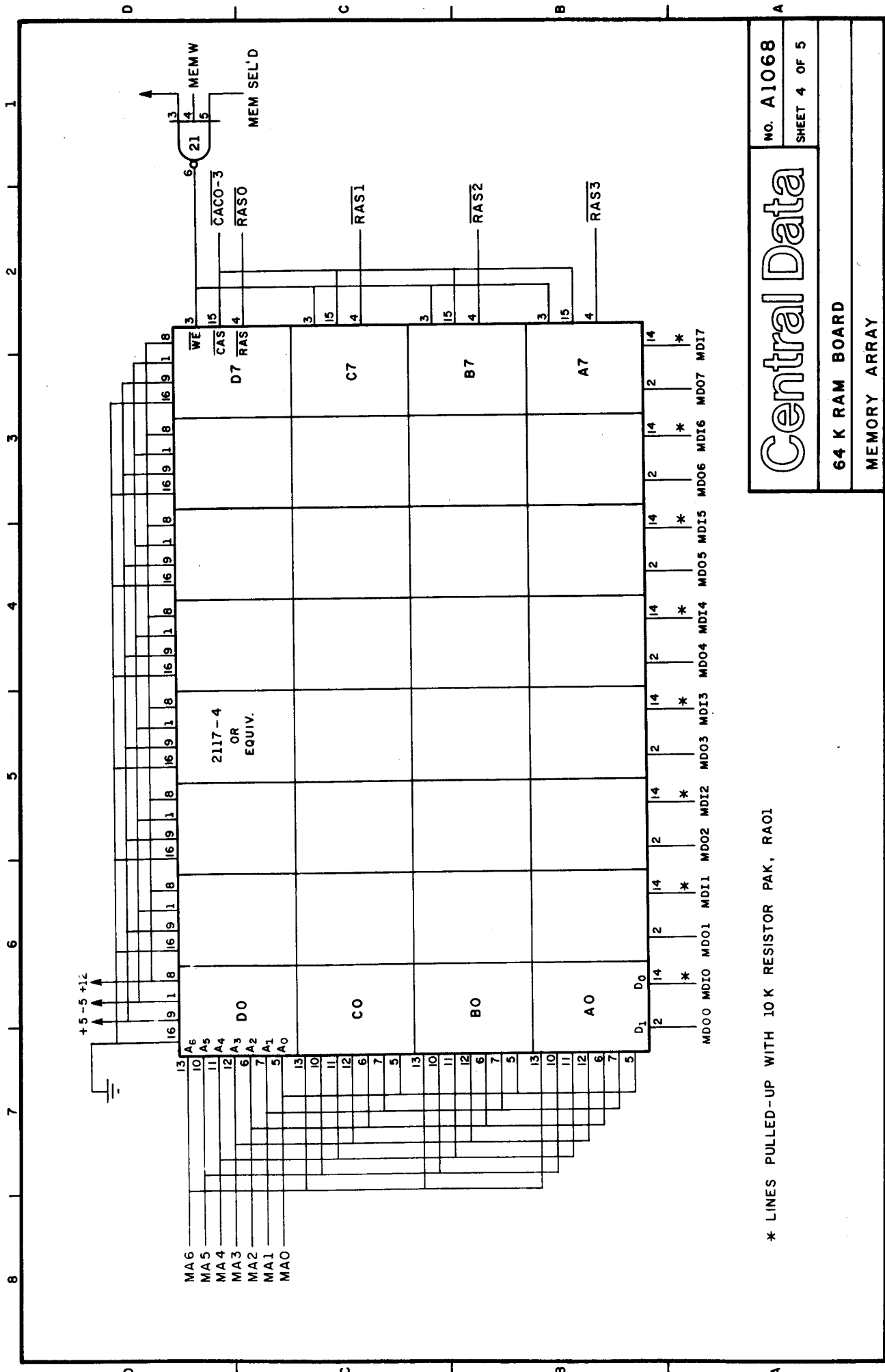

NO. A1068
SHEET 4 OF 5

Central Data

64 K RAM BOARD

MEMORY ARRAY

* LINES PULLED-UP WITH 10K RESISTOR PAK, RAO1

1 2 3 4 5 6 7 8

1 2 3 4 5 6 7 8

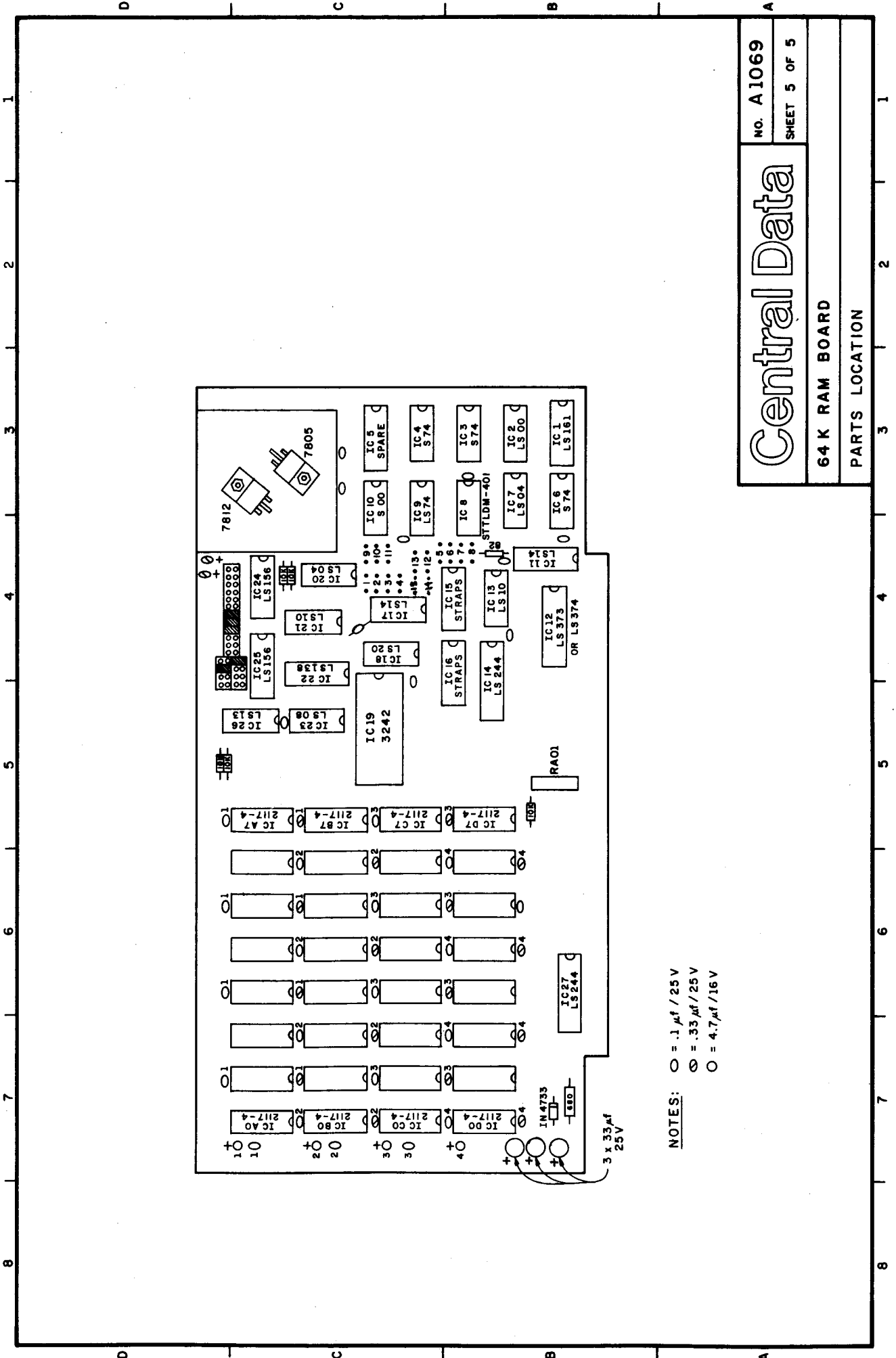

NO. A1069
SHEET 5 OF 5

Central Data

64 K RAM BOARD

PARTS LOCATION

- NOTES:**
- = .1 µF / 25V
 - ⊗ = .33 µF / 25V
 - = 4.7 µF / 16V